



NARDI

IMPLEMENTS FOR PROFESSIONAL FARMING



CAMBRIDGE ROLLER

▶ COLTIVATORI

▶ *CULTIVATORS*

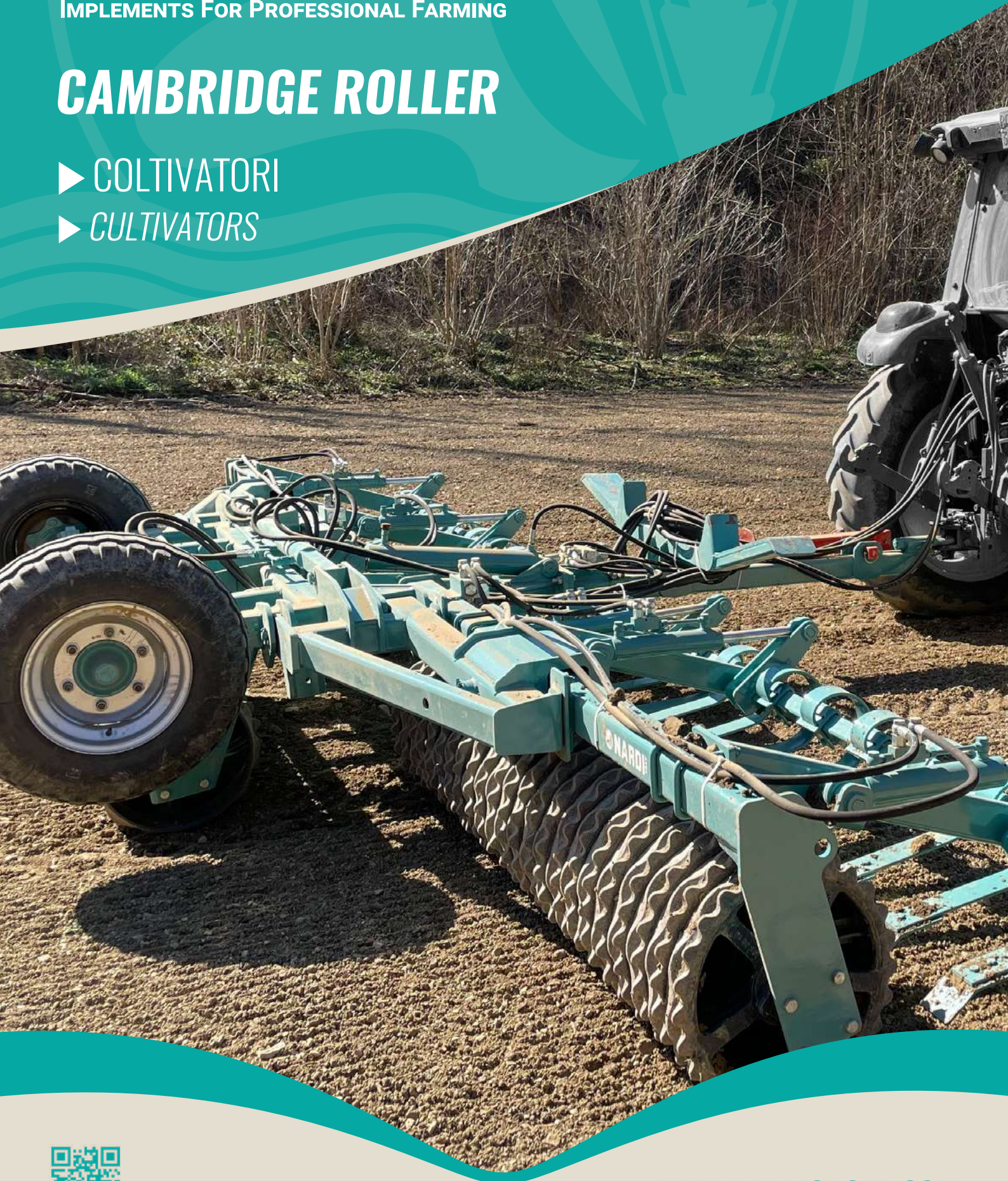

WWW.NARDIGROUP.COM

PRINCIPALI CARATTERISTICHE TECNICHE - MAIN TECHNICAL FEATURES



Sezioni indipendenti e oscillanti - Independent and oscillating sections

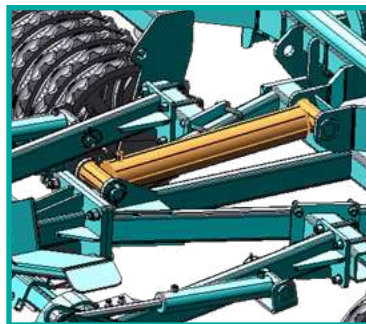

Azionamento idraulico trasporto/lavoro - Hydraulic drive transport/work

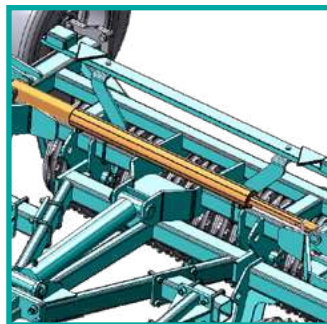

Apertura/chiusura idraulica delle sezioni laterali - Hydraulic opening/closing of the side sections

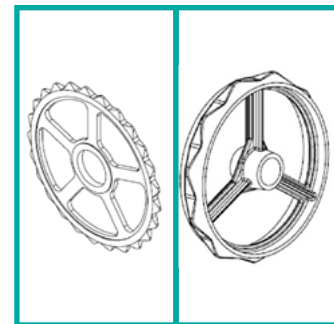

Disco in ghisa Ø 500 e Ø 520 - Cast iron disc Ø 500 and Ø 520

LA NOSTRA FORZA - OUR STRENGTH

- Bilanciamento centrale delle sezioni - Central balancing of sections
- Azionamento idraulico trasporto/lavoro - Hydraulic drive transport/work
- Sistema idraulico di apertura e chiusura rulli - Hydraulic system for opening and closing rollers
- Particolare disposizione dei dischi - Special arrangement of the discs





I VOSTRI VANTAGGI - YOUR ADVANTAGES

- I rulli indipendenti si adattano perfettamente alle variazioni del terreno - The independent rollers adapt perfectly to the variations of the soil
- Sempre il miglior assetto al lavoro - Always the best set-up at work
- Apertura e chiusura della macchina semplice ed eseguita senza scendere dal trattore - Simple opening and closing of the machine without leaving the tractor
- Maggiore efficienza nella frantumazione delle zolle - Greater efficiency in crushing clods

DI SERIE - AS STANDARD

- Omologato di serie per la circolazione al traino - Approved towing kit for road transportation
- Sezioni laterali indipendenti ed oscillanti, e timone flottante - Side sections, independent and oscillating and floating rudder
- Ribaltamento idraulico in 3 sezioni direttamente dal trattore - Frame with hydraulic turnover in three sections directly from the tractor
- Dischi in ghisa 530 mm, albero da 70 mm, supporti con cuscinetti ed ingrassatore - 530 mm diameter cast iron discs, mounted on a 70 mm shaft, supports with bearings and greaser
- Piede di appoggio con regolazione a manovella per stazionamento - Support foot with crank adjustment for parking
- Ruote tipo 10.0/75-15.3 con mozzo a 6 fori - Wheels 10.0/75-15.3 with six-hole hub
- Barra luci posteriore - Rear light bar

CARATTERISTICHE TECNICHE - TECHNICAL FEATURES

Mod. RCN							
	Codice	Hp.	Kw.	mm.	cm.	cm.	Kg.
RCN 450	---	60	45	530	255	450	2.525
RCN 530	---	70	52	530	255	530	2.895
RCN 630	---	80	60	530	255	630	3.346
RCN 760	---	90	67	530	255	760	3.818
RCN 820	---	100	75	530	300	820	4.295

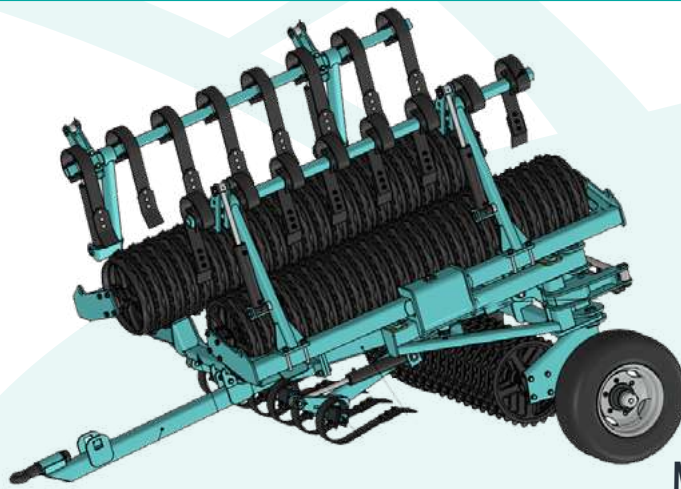

Mod. Cambridge Roller 630

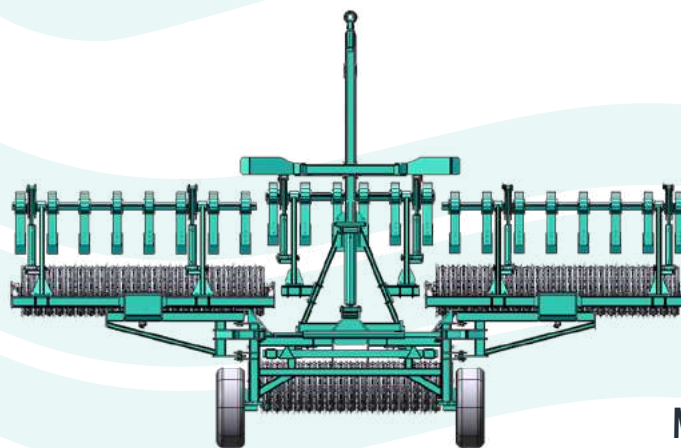

Mod. Cambridge Roller 630



NARDI

IMPLEMENTS FOR PROFESSIONAL FARMING

Via del Lavoro 24/26
06016 Selci Lama (PG) Italy
tel. +39 075 8610611
fax +39 075 8583446
www.nardigroup.com
e-mail: info@nardigroup.com
[Facebook.com/Nardi.spa](https://www.facebook.com/Nardi.spa)